

Download File PDF Honda Gx200 Engine Diagram

#Jenny



Finally I get this ebook, thanks for all these I can get now!

#Rio



Cool! I'am really happy

#Markus Jensen



I did not think that this would work, my best friend showed me this website, and it does! I get my most wanted eBook

#Hun Tsu



wtf this great ebook for free?!

#Che Salsa



My friends are so mad that they do not know how I have all the high quality ebook which they do not!

#Diego Butler



so many fake sites. this is the first one which worked! Many thanks

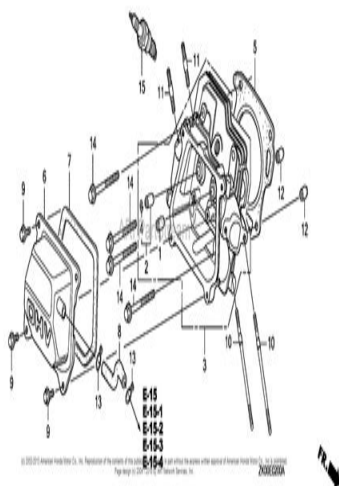

[Download PDF version of :](#)
Honda Gx200 Engine Diagram